

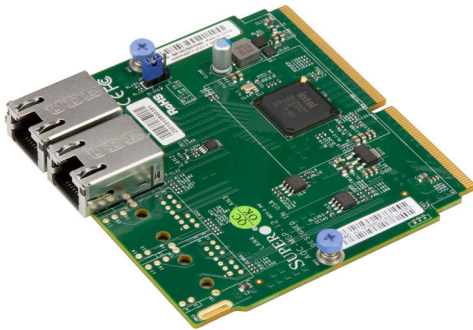

AOC-MGP-i2

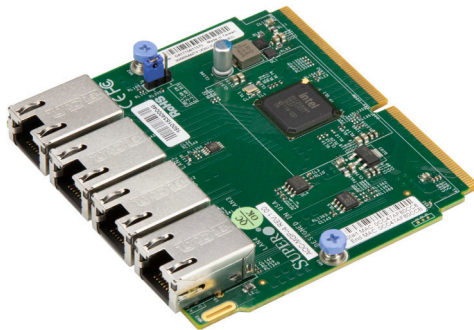

AOC-MGP-i4



User's Guide

Revision 1.0a

The information in this user's guide has been carefully reviewed and is believed to be accurate. The vendor assumes no responsibility for any inaccuracies that may be contained in this document, and makes no commitment to update or to keep current the information in this user's guide, or to notify any person or organization of the updates. **Please Note: For the most up-to-date version of this user's guide, please see our Website at www.supermicro.com.**

Super Micro Computer, Inc. ("Supermicro") reserves the right to make changes to the product described in this user's guide at any time and without notice. This product, including software and documentation, is the property of Supermicro and/or its licensors, and is supplied only under a license. Any use or reproduction of this product is not allowed, except as expressly permitted by the terms of said license.

IN NO EVENT WILL SUPER MICRO COMPUTER, INC. BE LIABLE FOR DIRECT, INDIRECT, SPECIAL, INCIDENTAL, SPECULATIVE OR CONSEQUENTIAL DAMAGES ARISING FROM THE USE OR INABILITY TO USE THIS PRODUCT OR DOCUMENTATION, EVEN IF ADVISED OF THE POSSIBILITY OF SUCH DAMAGES. IN PARTICULAR, SUPER MICRO COMPUTER, INC. SHALL NOT HAVE LIABILITY FOR ANY HARDWARE, SOFTWARE, OR DATA STORED OR USED WITH THE PRODUCT, INCLUDING THE COSTS OF REPAIRING, REPLACING, INTEGRATING, INSTALLING OR RECOVERING SUCH HARDWARE, SOFTWARE, OR DATA.

Any disputes arising between the manufacturer and the customer shall be governed by the laws of Santa Clara County in the State of California, USA. The State of California, County of Santa Clara shall be the exclusive venue for the resolution of any such disputes. Supermicro's total liability for all claims will not exceed the price paid for the hardware product.

FCC Statement: This equipment has been tested and found to comply with the limits for a Class A digital device pursuant to Part 15 of the FCC Rules. These limits are designed to provide reasonable protection against harmful interference when the equipment is operated in a commercial environment. This equipment generates, uses, and can radiate radio frequency energy and, if not installed and used in accordance with the manufacturer's instruction manual, may cause harmful interference with radio communications. Operation of this equipment in a residential area is likely to cause harmful interference, in which case you will be required to correct the interference at your own expense.

California Best Management Practices Regulations for Perchlorate Materials: This Perchlorate warning applies only to products containing CR (Manganese Dioxide) Lithium coin cells. "Perchlorate Material-special handling may apply. See www.dtsc.ca.gov/hazardouswaste/perchlorate".



WARNING: This product can expose you to chemicals including lead, known to the State of California to cause cancer and birth defects or other reproductive harm. For more information, go to www.P65Warnings.ca.gov.

User's Guide Revision 1.0a

Release Date: December 6, 2019

Unless you request and receive written permission from Super Micro Computer, Inc., you may not copy any part of this document.

Information in this document is subject to change without notice. Other products and companies referred to herein are trademarks or registered trademarks of their respective companies or mark holders.

Copyright © 2019 by Super Micro Computer, Inc.
All rights reserved.

Printed in the United States of America

Preface

About this User's Guide

This user's guide is written for system integrators, IT technicians, and knowledgeable end users. It provides information for the installation and use of the AOC-MGP-i2/i4 add-on card.

About this Add-on Card

The Supermicro® Super I/O Modules provide flexible I/O networking options and the AOC-MGP-i2 and AOC-MGP-i4 are the most flexible and scalable GbE SIOM controllers with dual and quad-port options. Based on the Intel® GbE network controller i350, the AOC-MGP-i2 and AOC-MGP-i4 are designed with performance enhancing features and power management technologies.

An Important Note to the User

All images and layouts shown in this user's guide are based upon the latest PCB revision available at the time of publishing. The card you have received may or may not look exactly the same as the graphics shown in this user's guide.

Returning Merchandise for Service

A receipt or copy of your invoice marked with the date of purchase is required before any warranty service will be rendered. You can obtain service by calling your vendor for a Returned Merchandise Authorization (RMA) number. When returning the motherboard to the manufacturer, the RMA number should be prominently displayed on the outside of the shipping carton, and the shipping package is mailed prepaid or hand-carried. Shipping and handling charges will be applied for all orders that must be mailed when service is complete. For faster service, you can also request a RMA authorization online <http://www.supermicro.com/RmaForm/>.

This warranty only covers normal consumer use and does not cover damages incurred in shipping or from failure due to the alternation, misuse, abuse or improper maintenance of products.

During the warranty period, contact your distributor first for any product problems.

Conventions Used in the User's Guide

Pay special attention to the following symbols for proper system installation and for safety instructions to prevent damage to the system or injury to yourself:

 **Warning:** Important information given to ensure proper system installation or to prevent damage to the components or injury to yourself.

 **Note:** Additional information given for proper system setup.

Naming Convention for Standard Network Adaptors

A O C - M H I B F - 2 Q G

|
|
|
|
|
|
|
|
|

1
-
2
3
-
6
7
8

Character	Representation	Options
1st	Product Family	AOC: Add On Card
2nd	Form Factor	S: Standard, P: Proprietary, C: MicroLP, M: Super IO Module (SIOM), MH: SIOM Hybrid
3rd	Product Type/Speed	G: GbE (1Gb/s), TG: 10GbE (10Gb/s), 25G: 25GbE (25Gb/s), 40G: 40GbE (40Gb/s), 50G: 50GbE (50Gb/s), 100G: 100GbE (100Gb/s), IBE: EDR IB (100Gb/s), IBF: FDR IB (56Gb/s), IBQ: QDR IB (40Gb/s), HFI: Host Fabric Interface
4th	Chipset Model (Optional)	N: Niantec (82599), P: Powerville (i350), S: Sageville (X550)
5th	Chipset Manufacturer (Optional)	i: Intel, m: Mellanox, b: Broadcom
6th	Number of Ports	1: 1 port, 2: 2 ports, 4: 4 ports
7th	Connector Type (Optional)	S: SFP+/SFP28, T: 10GBase-T, Q: QSFP+, C: QSFP28
8th	2 nd Controller/Connector Type (Optional)	G: GbE RJ45, S: 10G SFP+, T: 10GBase-T

Networking Adapter List

Model	Type	Form Factor	Controller	Connection	Dimension (w/o Brackets) (L x H)	Power (W)
AOC-MGP-i2	GbE	SIOM	Intel® i350 AM2	2 RJ45 (1Gb/port)	3.622" (92mm) x 3.428" (87.08mm)	3.7
AOC-MGP-i4	GbE	SIOM	Intel® i350 AM4	4 RJ45 (1Gb/port)	3.622" (92mm) x 3.428" (87.08mm)	4.4
AOC-MTGN-i2S	10GbE	SIOM	Intel® 82599E5	2 SFP+ (10Gb/port)	3.622" (92mm) x 3.428" (87.08mm)	7.2
AOC-MTG-i4S	10GbE	SIOM	Intel® XL710-BM1	4 SFP+ (10Gb/port)	3.622" (92mm) x 3.428" (87.08mm)	7
AOC-MTG-b2T	10GbE	SIOM	Broadcom® BCM57416	2 RJ45 (10GBase-T)	3.622" (92mm) x 3.428" (87.08mm)	11
AOC-MTG-i2T	10GbE	SIOM	Intel® X550-A T2	2 RJ45 (10GBase-T)	3.622" (92mm) x 3.428" (87.08mm)	13
AOC-MTG-i4T	10GbE	SIOM	2x Intel® X550-A T2	4 RJ45 (10GBase-T)	3.622" (92mm) x 3.428" (87.08mm)	26
AOC-MHIBF-m1Q2G	FDR IB GbE	SIOM	Mellanox® ConnectX-3 Pro Intel® i350	1 QSFP (56Gb/port) 2 RJ45 (1Gb/port)	3.622" (92mm) x 3.428" (87.08mm)	9
AOC-MHIBF-m2Q2G	FDR IB GbE	SIOM	Mellanox® ConnectX-3 Pro Intel® i350	2 QSFP (56Gb/port) 2 RJ45 (1Gb/port)	3.622" (92mm) x 3.428" (87.08mm)	11
AOC-MHIBE-m1CG	EDR IB GbE	SIOM	Mellanox® ConnectX-4 VPI Intel® i210	1 QSFP28 (100Gb/port) 1 RJ45 (1Gb/port)	3.622" (92mm) x 3.428" (87.08mm)	19
AOC-MH25G-b2S2G	25GbE	SIOM	Broadcom® BCM57414 Intel® i350	2 SFP28 (25Gb/port) 2 RJ45 (1Gb/port)	3.622" (92mm) x 3.428" (87.08mm)	9
AOC-MH25G-m2S2T	25GbE	SIOM	Mellanox® ConnectX-4 Lx EN Intel® X550-A T2	2 SFP28 (25Gb/port) 2 RJ45 (10GBase-T)	3.622" (92mm) x 3.428" (87.08mm)	25
AOC-M25G-m4S	25GbE	SIOM	Mellanox® ConnectX-4 Lx EN	4 SFP28 (25Gb/port)	3.622" (92mm) x 3.428" (87.08mm)	20
AOC-M25G-i2S	25GbE	SIOM	Intel® XXV710	2 SFP28 (25Gb/port)	3.622" (92mm) x 3.428" (87.08mm)	11.8
AOC-MHFI-1C	Omni-Path	SIOM	Intel® OP HFI ASIC (Wolf River WFR-B)	1 QSFP28 (100Gb/port)	3.622" (92mm) x 3.428" (87.08mm)	15

Model	Type	Form Factor	Interface	Controller	Connection	Dimension (w/o Brackets) (L x H)	Power (W)
AOC-SQP-i2	QbE	Standard LP	PCI-E x4	Intel® i250 AM2	2 RJ45 (1Gb/port)	3.9" (99mm) x 2.73" (69mm)	3.5
AOC-SQP-i4	QbE	Standard LP	PCI-E x4	Intel® i250 AM4	4 RJ45 (1Gb/port)	3.9" (99mm) x 2.73" (69mm)	5
AOC-STG-i2T	10GbE	Standard LP	PCI-E x8	Intel® X540-AT2	2 RJ45 (10GBase-T)	5.9" (150mm) x 2.73" (69mm)	13
AOC-STG-i1T	10GbE	Standard LP	PCI-E x4	Intel® X550-AT	1 RJ45 (10GBase-T)	5.9" (150mm) x 2.73" (69mm)	9
AOC-STG-i2T	10GbE	Standard LP	PCI-E x4	Intel® X550-AT2	2 RJ45 (10GBase-T)	5.9" (150mm) x 2.73" (69mm)	11
AOC-STG-i2T	10GbE	Standard LP	PCI-E x8	Broadcom® BCM57416	2 RJ45 (10GBase-T)	5.6" (142mm) x 2.73" (69mm)	13.1
AOC-STG-i4T	10GbE	Standard LP	PCI-E x8	Intel® XL710-BM1	4 RJ45 (10GBase-T)	5.9" (149mm) x 2.73" (69mm)	15.5
AOC-STGN-i1S	10GbE	Standard LP	PCI-E x8	Intel® 82599EN	1 SFP+ (10Gb/port)	4.0" (102mm) x 2.73" (69mm)	10
AOC-STGN-i2S	10GbE	Standard LP	PCI-E x8	Intel® 82599ES	2 SFP+ (10Gb/port)	4.0" (102mm) x 2.73" (69mm)	11.2
AOC-STGF-i2S	10GbE	Standard LP	PCI-E x8	Intel® X710-BM2	2 SFP+ (10Gb/port)	5.19" (132mm) x 2.73" (69mm)	5.6
AOC-STG-b4S	10GbE	Standard LP	PCI-E x8	Broadcom® BCM5740S	4 SFP+ (10Gb/port)	5.4" (137mm) x 2.73" (69mm)	14
AOC-STG-i4S	10GbE	Standard LP	PCI-E x8	Intel® XL710-BM1	4 SFP+ (10Gb/port)	5.9" (150mm) x 2.73" (69mm)	8
AOC-S25G-m2S	25GbE	Standard LP	PCI-E x8	Mellanox® CX-4 LX	2 SFP28 (25Gb/port)	5.6" (142mm) x 2.713" (69mm)	8.7
AOC-S25G-b2S	25GbE	Standard LP	PCI-E x8	Broadcom® BCM57414	2 SFP28 (25Gb/port)	5.6" (142mm) x 2.713" (69mm)	5.2
AOC-S25G-i2S	25GbE	Standard LP	PCI-E x8	Intel® XXV710	2 SFP28 (25Gb/port)	6.1" (155mm) x 2.713" (69mm)	7.2
AOC-S40G-i1Q	40GbE	Standard LP	PCI-E x8	Intel® XL710-BM1	1 QSFP+ (40Gb/port)	5.9" (150mm) x 2.73" (69mm)	6.5
AOC-S40G-i2Q	40GbE	Standard LP	PCI-E x8	Intel® XL710-BM2	2 QSFP+ (40Gb/port)	5.9" (150mm) x 2.73" (69mm)	7
AOC-S100G-m2C	100GbE	Standard LP	PCI-E x16	Mellanox® CX-4 EN	2 QSFP28 (100Gb/port)	6.6" (168mm) x 2.73" (69mm)	16.3
AOC-S100G-b1C	100GbE	Standard LP	PCI-E x16	Broadcom® BCM57454	2 QSFP28 (100Gb/port)	6.6" (168mm) x 2.73" (69mm)	17.8
AOC-CGP-i2	QbE	MicroLP	PCI-E x4	Intel® i250 AM2	2 RJ45 (1Gb/port)	4.46" (113mm) x 1.54" (39mm)	4
AOC-CTG-i1S	10GbE	MicroLP	PCI-E x8	Intel® 82599EN	1 SFP+ (10Gb/port)	4.85" (123mm) x 1.54" (39mm)	10
AOC-CTG-i2S	10GbE	MicroLP	PCI-E x8	Intel® 82599ES	2 SFP+ (10Gb/port)	4.85" (123mm) x 1.54" (39mm)	11
AOC-CTG-i2T	10GbE	MicroLP	PCI-E x8	Intel® X540-AT2	2 RJ45 (10GBase-T)	4.8" (123mm) x 2.75" (77mm)	13
AOC-CTG-i2T	10GbE	MicroLP	PCI-E x4	Intel® X550-AT2	2 RJ45 (10GBase-T)	4.45" (113mm) x 1.54" (39mm)	12
AOC-C25G-m1S	25GbE	MicroLP	PCI-E x8	Mellanox® CX-4 Lx EN	1 SFP28 (25Gb/port)	4.45" (113mm) x 1.54" (39mm)	8.5

Contacting Supermicro

Headquarters

Address: Super Micro Computer, Inc.
980 Rock Ave.
San Jose, CA 95131 U.S.A.

Tel: +1 (408) 503-8000

Fax: +1 (408) 503-8008

Email: marketing@supermicro.com (General Information)
support@supermicro.com (Technical Support)

Website: www.supermicro.com

Europe

Address: Super Micro Computer B.V.
Het Sterrenbeeld 28, 5215 ML
's-Hertogenbosch, The Netherlands

Tel: +31 (0) 73-6400390

Fax: +31 (0) 73-6416525

Email: sales@supermicro.nl (General Information)
support@supermicro.nl (Technical Support)
rma@supermicro.nl (Customer Support)

Website: www.supermicro.nl

Asia-Pacific

Address: Super Micro Computer, Inc.
3F, No. 150, Jian 1st Rd.
Zhonghe Dist., New Taipei City 235
Taiwan (R.O.C)

Tel: +886-(2) 8226-3990

Fax: +886-(2) 8226-3992

Email: support@supermicro.com.tw

Website: www.supermicro.com.tw

Table of Contents

Preface

About this User's Guide	3
About this Add-on Card	3
An Important Note to the User	3
Returning Merchandise for Service.....	3
Naming Convention for Standard Network Adaptors	4
Networking Adapter List	4
Conventions Used in the User's Guide	4
Contacting Supermicro	6

Chapter 1 Overview

1-1 Overview	1-1
1-2 Product Highlights	1-1
1-3 Technical Specifications	1-2
General.....	1-2
Ethernet Features	1-2
Power Management and Efficiency	1-2
Virtualization Features.....	1-3
Performance Features	1-3
OS Support	1-3
Cable Support	1-4
Power Consumption	1-4
Operating Conditions	1-4
Physical Dimensions	1-4
Compliance Platforms	1-4
Supported Platforms	1-4

Chapter 2 Hardware Components

2-1 Add-On Card Image and Layout.....	2-1
2-2 Major Components.....	2-3
2-3 LAN Ports and LAN LED Indicators.....	2-4
LAN Ports	2-4
LAN Port LED Indicators.....	2-4
2-4 Jumpers.....	2-5
Explanation of Jumpers	2-5
LAN Port Enable/Disable	2-5

Chapter 3 Installation

3-1	Static-Sensitive Devices.....	3-1
	Precautions	3-1
	Unpacking	3-1
3-2	Before Installation	3-2
3-3	Installing the Add-on Card	3-2
3-4	Installing Drivers on Windows.....	3-4
3-5	Installing Drivers on Linux	3-4
	Build a Binary RPM Package.....	3-4
3-6	Installing Drivers on FreeBSD	3-6

Chapter 1

Overview

1-1 Overview

Congratulations on purchasing your add-on card from an acknowledged leader in the industry. Supermicro products are designed with the utmost attention to detail to provide you with the highest standards in quality and performance. For product support and updates, please refer to our website at <http://www.supermicro.com/products/info/networking.cfm#adapter>.

1-2 Product Highlights

The product highlights of this add-on card include the following:

- Super I/O Module (SIOM) Form Factor
- Intel® i350 GbE controller
- Dual and Quad RJ45 Connectors
- VMDq and SR-IOV for Virtualized Environments
- Jumbo Frames support
- Energy Efficient Ethernet (EEE)
- iSCSI Remote Boot Support
- PXE Boot Support
- Support for most Network Operating Systems
- Asset Management Features
- NC-SI for Remote Management
- RoHS compliant 6/6

1-3 Technical Specifications

General

- Intel® i350 GbE controller
- Super I/O Module (SIOM) Form Factor
- Dual RJ45 ports (AOC-MGP-i2)
- Quad RJ45 ports (AOC-MGP-i4)
- Load balancing on multiple CPUs
- Intel I/O Acceleration Technology (Intel I/OAT)

Ethernet Features

- IEEE 802.3 auto-negotiation for speed, duplex, and flow control
- IEEE 802.3x and 802.3z compliant flow control support
- Automatic cross-over detection function (MDI/MDI-X)
- 1Gb/s Ethernet IEEE 802.3, 802.3u, 802.3ab PHY specifications Compliant
- IEEE 1588 protocol and 802.1AS implementation

Power Management and Efficiency

- Energy Efficient Ethernet (EEE)
- DMA Coalescing reduces platform power consumption
- Active State Power Management (ASPM) support
- LAN disable function
- MAC Power Management controls
- Low Power Link Up – Link Speed Control

Virtualization Features

- PCI-SIG SR-IOV support
- VM to VM Packet forwarding (Packet Loopback)
- Flexible Port Partitioning
- IEEE 802.1q VLAN support
- IEEE 802.1q advanced packet filtering
- Jumbo Frames support

Performance Features

- TCP/UDP, IPv4 and IPv6 checksum offloads to improve CPU usage
- Low Latency Interrupts
- Tx TCP segmentation offload (IPv4, IPv6) increases throughput and lowers processor usage
- Receive Side Scaling (RSS) for Windows environment, Scalable I/O for Linux environments
- Intelligent interrupt generation
- TCP segmentation/large send offload
- Interrupt moderation

OS Support

The AOC-MGP-i2/i4 add-on card supports the following operating systems:

- Windows Server 2012 R2, 2012, 2008 R2 (x64 Edition)
- Windows 8.1, 8, 7 (x64 Edition)
- RedHat Linux
- SUSE Linux
- FreeBSD

- UEFI
- VMware

Cable Support

- RJ45 Category 5/5e up to 100m

Power Consumption

- AOC-MGP-i2: Typical 3W, Maximum 3.7W
- AOC-MGP-i4: Typical 3.7W, Maximum 4.4W

Operating Conditions

- Operating temperature: 0°C to 55°C (32°F to 131°F)
- Storage temperature: -40°C to 70°C (-40°F to 158°F)
- Storage humidity: 90% non-condensing relative humidity at 35°C

Physical Dimensions

- Card PCB dimensions: 92mm (3.62in) x 87.1mm (3.43in) (W x D)

Compliance Platforms

- RoHS Compliant 6/6, Pb Free



Supported Platforms

- Supermicro® motherboards with Super I/O Module slot
- Supermicro® server systems with Super I/O Module slot

Chapter 2

Hardware Components

2-1 Add-On Card Image and Layout

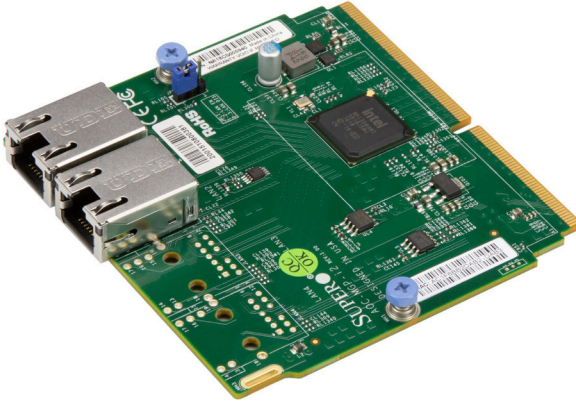

The AOC-MGP-i2 Image

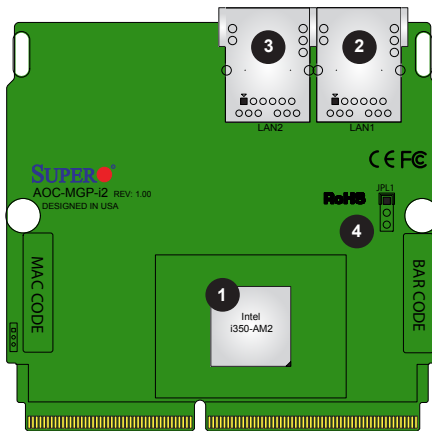

The AOC-MGP-i2 Layout

Components	
1. Intel i350-AM2	3. RJ45 LAN Port 2
2. RJ45 LAN Port 1	4. JPL1

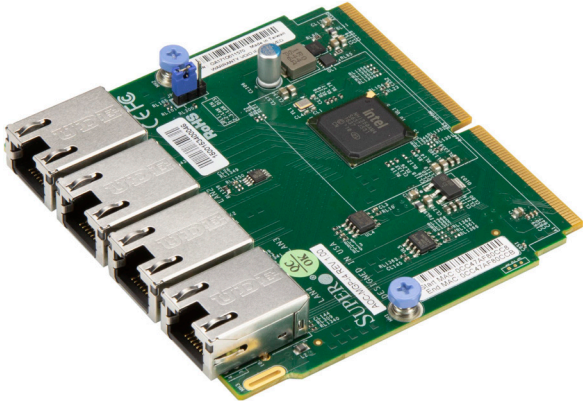

The AOC-MGP-i4 Image

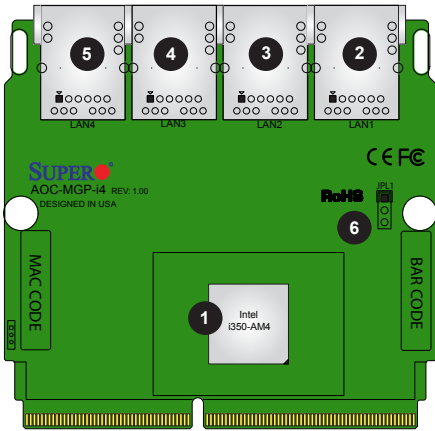

The AOC-MGP-i4 Layout

Components	
1. Intel i350-AM4	4. RJ45 LAN Port 3
2. RJ45 LAN Port 1	5. RJ45 LAN Port 4
3. RJ45 LAN Port 2	6. JPL1

2-2 Major Components

The following major components are on the AOC-MGP-i2:

1. Intel i350-AM2
2. LAN Port 1
3. LAN Port 2
4. JPL1 - LAN Port Enable/Disable

The following major components are on the AOC-MGP-i4:

1. Intel i350-AM4
2. LAN Port 1
3. LAN Port 2
4. LAN Port 3
5. LAN Port 4
6. JPL1 - LAN Port Enable/Disable

2-3 LAN Ports and LAN LED Indicators

LAN Ports

There are two 1GbE LAN ports on the AOC-MGP-i2 and four 1GbE LAN ports on the AOC-MGP-i4. These LAN ports support connection speeds of 1Gbps. Use a direct-attach RJ45 type LAN cable.

 **Note:** Please refer to "Optional Accessories" on page 1-4 for recommended cables.

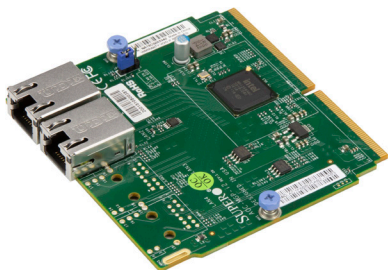

The AOC-MGP-i2 Image

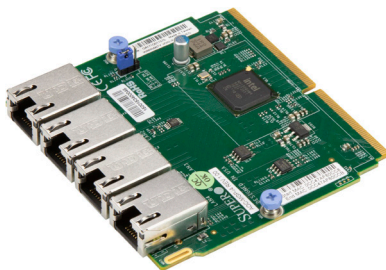

The AOC-MGP-i4 Image

LAN Port LED Indicators

Each LAN port has two LEDs to indicate speed and data activity. Refer to the table below for LED color and definition.

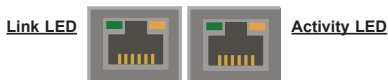

LAN Port Link LED (Left) LED State	
LED Color	Definition
Green	100 Mbps
Amber	1 Gbps
Off	No Connection

LAN Port Activity LED (Right) LED State		
Color	Status	Definition
Yellow	Flashing	Active

2-4 Jumpers

Explanation of Jumpers

To modify the operation of the add-on card, a jumper can be used to choose between optional settings. A jumper creates shorts between two pins to change the function of the connector. Pin 1 is identified with a square solder pad on the printed circuit board. See the add-on card layout on pages 2-1 and 2-2 for the jumper location.



Note: On two-pin jumpers, "Closed" means the jumper is on and "Open" means the jumper is off the pins.

LAN Port Enable/Disable

Use jumper JPL1 to enable or disable LAN ports 1 and 2 on the AOC-MGP-i2. On the AOC-MGP-i4, this jumper will enable or disable LAN ports 1, 2, 3, and 4. See the table below for jumper settings. The default setting is Enabled.

LAN Port Enable/Disable Jumper Settings	
Jumper setting	Definition
Pins 1-2	Enabled
Pins 2-3	Disabled

Notes

Chapter 3

Installation

3-1 Static-Sensitive Devices

Electrostatic Discharge (ESD) can damage electronic components. To avoid damaging your add-on card, it is important to handle it very carefully. The following measures are generally sufficient to protect your equipment from ESD.

Precautions

- Use a grounded wrist strap designed to prevent static discharge.
- Touch a grounded metal object before removing the add-on card from the antistatic bag.
- Handle the add-on card by its edges only; do not touch its components.
- Put the add-on card back into the antistatic bags when not in use.
- For grounding purposes, make sure that your system chassis provides excellent conductivity between the power supply, the case, the mounting fasteners and the add-on card.

Unpacking

The add-on card is shipped in antistatic packaging to avoid static damage. When unpacking your component or system, make sure you are static protected.



Note: To avoid damaging your components and to ensure proper installation, always connect the power cord last, and always unplug it before adding, removing or changing any hardware components.

3-2 Before Installation

Before you install the add-on card, follow the instructions below.

1. Power down the system.
2. Unplug the power cord.
3. Use industry-standard anti-static equipment such as gloves or a wrist strap and follow the precautions on page 3-1 to avoid damage caused by ESD.
4. Familiarize yourself with the server, motherboard, and/or chassis documentation.
5. Confirm that your operating system includes the latest updates and hotfixes.

3-3 Installing the Add-on Card

Follow the steps below to install the add-on card into your system.

1. Remove the server cover and, if any, set aside any screws for later use.
2. Remove the add-on card slot cover. If the slot cover has a screw, place it aside for later use.
3. Position the add-on card in front of the SIOM slot and gently push in both sides of the card until it slides into the slot.

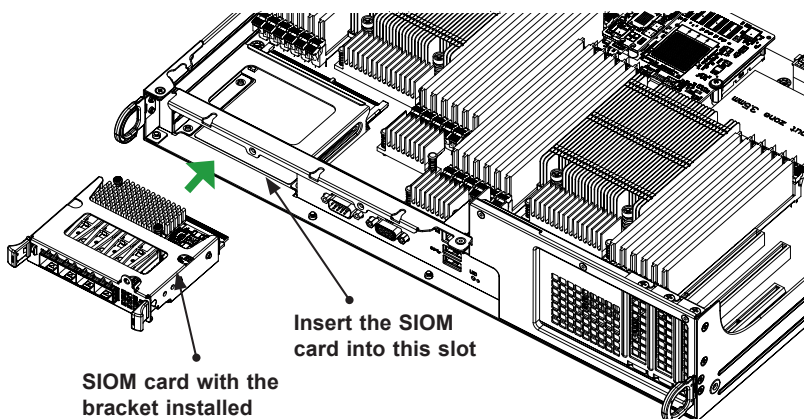

 **Note:** This add-on card does not support hot plug. Please turn off the AC power and remove the power cord from the wall socket before you install or remove the add-on card.

Follow this step to install the add-on card if your system does not support a swappable bracket. Insert the SIOM card in the motherboard and then install the motherboard in the chassis. An internal bracket comes with the SIOM card 1U chassis SKU. It needs to be installed onto the chassis.

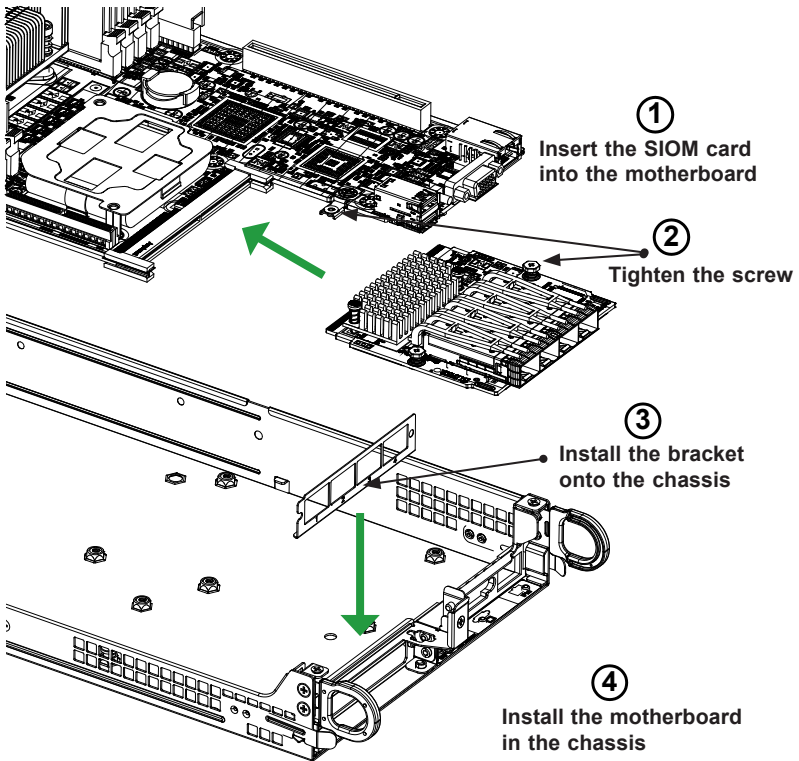

 **Note:** It is recommended that the SIOM card installation above be completed by a system integrator or the manufacturer.

4. Secure the add-on card to the chassis. If required, use the screw that you previously removed.
5. Attach any necessary external cables to the add-on card.
6. Replace the system cover.
7. Plug in the power cord and power up the system.

3-4 Installing Drivers on Windows

Follow the steps below to install the drivers for Windows. Download the drivers from the Supermicro FTP site at ftp://ftp.supermicro.com/Networking_Drivers/.

1. Run CDR-NIC.
2. When the SUPERMICRO window appears, click on the computer icon next to the product model.

 **Note:** If the *FOUND NEW HARDWARE WIZARD* screen displays on your system, click CANCEL.



SUPERMICRO Add-On Card Drivers and Tools (Win8.1)

SUPERMICRO Drivers & Tools

SUPERMICRO Computer Inc.

- Intel 10GbE Adapters**
UTG-i2, STG-i2, STGN-i2S, STG-i2T, CTG-i1S, CTG-i2S, MH25G-m2S2T, STGF-i2S, MTG-i4S
- IB Adapters (IB drivers)**
UIBF-m2, UIBQ-m1, UIBQ-m2, R1UG-iBQ, CIBF-m1, CIBQ-m1, UIBF-m1, MHIBF-m1Q2G, MHIBF-m2Q2G, MHIBE-m1CG
- IB Adapters (Ethernet drivers)**
UIBF-m2, UIBQ-m1, UIBQ-m2, R1UG-iBQ, CIBF-m1, CIBQ-m1, UIBF-m1
- Intel 1GbE Adapters**
UJG-i4, PG-i2, SG-i2, SG-i4, SGP-i4, CGP-i2, SGP-i2, CG-i2, MHIBF-m1Q2G, MHIBF-m2Q2G, MHIBE-m1CG, AG-i8, MGP-i2, MGP-i4
- Intel Omni Path 100G Adapters**
MHFI-i1C, SHFI-i1C
- Broadcom 1GbE Adapters**
MG-b2
- Broadcom 10GbE Adapters**
MTG-b2T, STG-b2T
- Broadcom 25GbE Adapters**
MH25G-b2S2G, S25G-b2S
- Broadcom 100GbE Adapters**
S100G-b1C
- Mellanox 25GbE Adapters**
C25G-m2S, C25G-m1S, MH25G-m2S2T, S25G-m2S, M25G-m4S
- Intel 25GbE Adapters**
M25G-i2S, S25G-i2S
- Mellanox 100GbE Adapters**
S100G-m2C
- Intel 40GbE Adapters**
S40G-i1Q, S40G-i2Q
- STG-b4S 10GbE Adapters**
- Read Product Description and Manual

For more information, please visit SUPERMICRO's web site.

3. Click on INSTALL DRIVERS AND SOFTWARE.
4. Follow the prompts to complete the installation.

3-5 Installing Drivers on Linux

Follow the steps below to install the drivers in Linux.

Build a Binary RPM Package

1. Run 'rpmbuild -tb <filename.tar.gz>'
2. Replace <filename.tar.gz> with the specific filename of the driver.



Note: For the build to work properly, the current running kernel **MUST** match the version and configuration of the installed kernel sources. If you have just recompiled the kernel, reboot the system at this time.

Follow the instructions below to build the driver manually.

1. Move the base driver tar file to the directory of your choice. For example:

```
/home/username/ixgbe
```

or

```
/usr/local/src/ixgbe
```

2. Untar/unzip archive, where <x.x.x> is the version number for the driver tar file:

```
tar xzf ixgbe-x.x.x.tar.gz
```

3. Change to the driver src directory, where <x.x.x> is the version number for the driver tar:

```
cd ixgbe-x.x.x/src/
```

4. Compile the driver module:

```
make install
```

The binary will be installed as:

```
/lib/modules/[KERNEL_VERSION]/kernel/drivers/net/ixgbe/ixgbe.[k]o
```

The install locations listed above are the default locations. They may not be correct for certain Linux distributions. For more information, see the `ldistrib.txt` file included in the driver tar.



Note: `IXGBE_NO_LRO` is a compile time flag. The user can enable it at compile time to remove support for LRO from the driver. The flag is used by adding `CFLAGS_EXTRA="-DIXGBE_NO_LRO"` to the make file when it's being compiled.

```
make CFLAGS_EXTRA="-DIXGBE_NO_LRO" install
```

5. Load the module:

For kernel 2.6.x, use the `modprobe` command:

```
modprobe ixgbe <parameter>=<value>
```

For 2.6 kernels, the `insmod` command can be used if the full path to the driver module is specified. For example:

```
insmod /lib/modules/<KERNEL VERSION>/kernel/drivers/net/  
ixgbe/ixgbe.ko
```

In addition, when using 2.6-based kernels, make sure that older `ixgbe` drivers are removed from the kernel before loading the new module. To do this, use:

```
rmmod ixgbe; modprobe ixgbe
```

6. Assign an IP address to the interface by entering the following, where `x` is the interface number:

```
ifconfig ethx <IP_address> netmask <netmask>
```

7. Verify that the interface works. Enter the following, where `<IP_address>` is the IP address for another machine on the same subnet as the interface that is being tested:

```
ping <IP_address>
```

3-6 Installing Drivers on FreeBSD

Follow the instructions below to install the drivers in FreeBSD kernel 4.8 or later. In the instructions below, x.x.x is the driver version as indicated in the name of the drive tar file.



Note: You must have kernel sources installed in order to compile the driver module.

1. Move the base driver tar file to the directory of your choice. For example, use `/home/username/ixgb` or `/usr/local/src/ixgb`.

2. Untar/unzip the archive:

```
tar xfz ixgb-x.x.x directory
```

3. To install man page:

```
cd ixgb-x.x.x
gzip -c ixgb.4 > /usr/share/man/man4/ixgb.4.gz
```

4. To load the driver onto a running system, perform the following steps:

```
cd ixgb-x.x.x
make
or
cd ixgb-x.x.x/src
make load
```

5. To assign an IP address to the interface, enter the following:

```
ifconfig ixgb<interface_num> <IP_address>
```

6. Verify that the interface works. Enter the following, where `<IP_address>` is the IP address for another machine on the same subnet as the interface that is being tested:

```
ping <IP_address>
```

7. If you want the driver to load automatically when the system is booted:

```
cd ixgb-x.x.x/src
make load
cp if_ixgb.ko /modules
```

Edit `/boot/loader.conf`, and add the following line:

```
if_ixgb_load="YES"
```

or

compile the driver into the kernel (see item 8). Edit `/etc/rc.conf`, and create the appropriate `ifconfig_ixgb<interface_num>` entry:

```
ifconfig_ixgb<interface_num>="<ifconfig_settings>"
```

Example usage:

```
ifconfig_ixgb0="inet 192.168.10.1 netmask 255.255.255.0"
```

8. If you want to compile the driver into the kernel, enter:

```
cd ixgb-x.x.x/src
mkdir /usr/src/sys/dev/ixgb
cp if_ixgb* /usr/src/sys/dev/ixgb
cp ixgb* /usr/src/sys/dev/ixgb
cp Makefile.kernel /usr/src/sys/modules/ixgb/Makefile
```

Edit the `/usr/src/sys/conf/files.i386` file, and add the following line:

```
dev/ixgb/ixgb_hw.c optional ixgb
dev/ixgb/ixgb_ee.c optional ixgb
dev/ixgb/if_ixgb.c optional ixgb
```

Remove the following lines from the `/usr/src/sys/conf/files.i386` file, if they exist:

```
/dev/ixgb/if_ixgb_fx_hw.c optional ixgb
/dev/ixgb/if_ixgb_phy.c optional ixgb
```

Edit the kernel configuration file (i.e., `GENERIC` or `MYKERNEL`) in `/usr/src/sys/i386/conf`, and ensure the following line is present:

```
device ixgb
```

Compile and install the kernel. Reboot the system for the kernel updates to take affect.

(Disclaimer Continued)

The products sold by Supermicro are not intended for and will not be used in life support systems, medical equipment, nuclear facilities or systems, aircraft, aircraft devices, aircraft/emergency communication devices or other critical systems whose failure to perform be reasonably expected to result in significant injury or loss of life or catastrophic property damage. Accordingly, Supermicro disclaims any and all liability, and should buyer use or sell such products for use in such ultra-hazardous applications, it does so entirely at its own risk. Furthermore, buyer agrees to fully indemnify, defend and hold Supermicro harmless for and against any and all claims, demands, actions, litigation, and proceedings of any kind arising out of or related to such ultra-hazardous use or sale.