



WEEE DISASSEMBLY INSTRUCTIONS

SUPERMICRO SYS-121H-TNR ENCLOSURE

Abstract

This document provides clear guidance for end-of-life recyclers on how to identify and disassemble reportable materials in compliance with the Waste Electrical and Electronic Equipment (WEEE) directive.

Table of Contents

1.	Product Views.....	1
2.	Reportable Materials on SYS-121H-TNR.....	3
3.	Disassemble Instructions	4
	3.3 Step-by-Step Disassembly Instructions	6
1.	Removing Power Cable and Chassis Top Cover	6
2.	Removing Hard Disk Drive (HDD)/ Solid State Drive (SSD)	7
3.	Removing Power Supply	8
4.	Removing Backplane	9
5.	Removing Fan	10
6.	Removing AIOM Card/ Add on Card/ TPM.....	10
7.	Removing Riser Card and Riser Bracket.....	12
8.	Removing Processor	12
9.	Removing DIMM.....	14
10.	Removing M.2.....	14
11.	Removing Motherboard.....	15

1. Product Views

Front view



Rear view



Product construct view

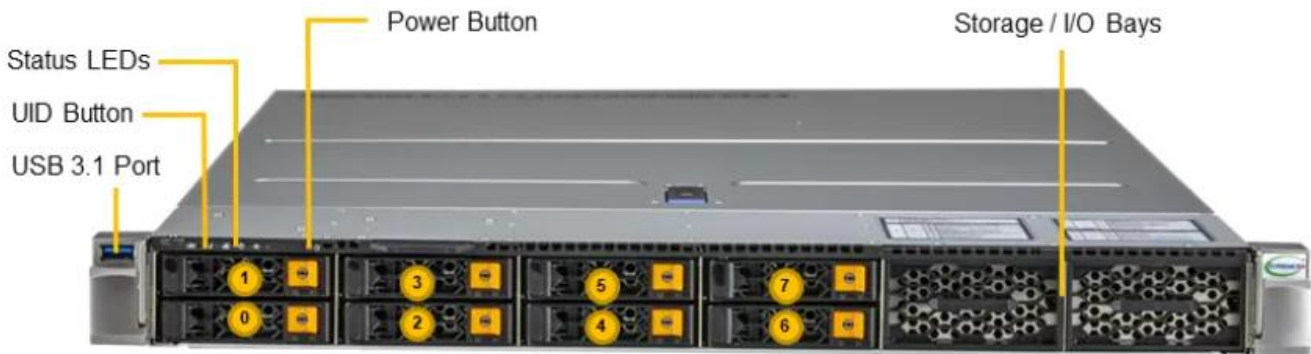

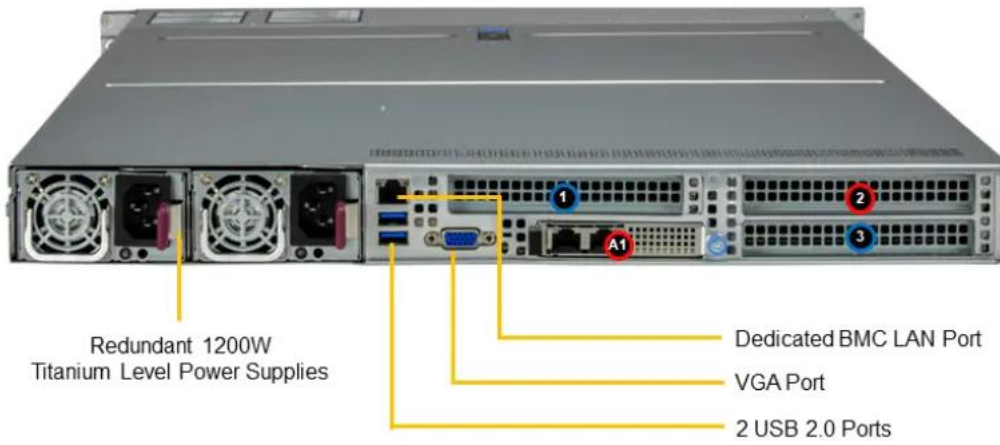
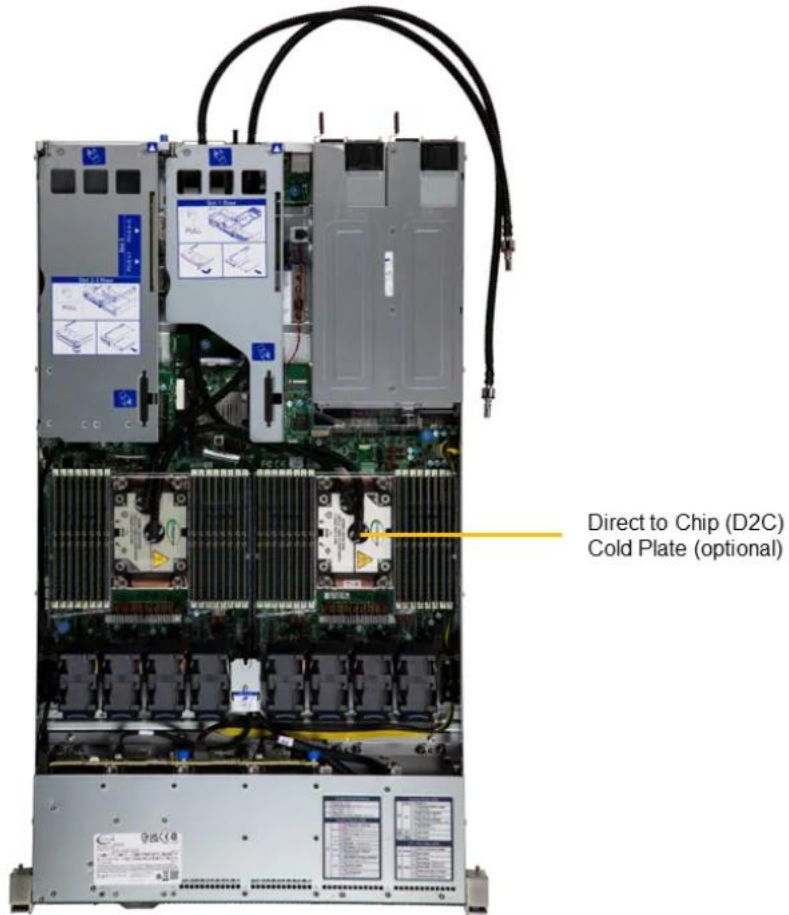

2. Reportable Materials on SYS-121H-TNR

According to Article 8(2) and Annex VII of WEEE directive 2012/19/EU, Below materials and components should be selectively treated.

Description	Notes	No.	Quantity
Printed Circuit Boards (PCB) or Printed Circuit Assemblies (PCA)	With a surface greater than 10 sq cm (Depending on the configuration)	2.4,3.5,4.1,5.1,6.1,6.2,6.3,6.4 7.2,8.2,9.1,10.111.1	21
Batteries	All types, including standard alkaline and lithium coin or button style batteries	11.2	1
Mercury-containing components	For example, mercury in lamps, display backlights, scanner lamps, switches, batteries		
Liquid Crystal Displays (LCD) with a surface greater than 100 sq cm	Includes background illuminated displays with gas discharge lamps		
Cathode Ray Tubes (CRT)			
Capacitors / condensers (Containing PCB/PCT)			
Electrolytic Capacitors / Condensers measuring greater than 2.5 cm in diameter or height	(Depending on the power supply model)	3.6	2
External electrical cables and cords		1.1	2
Gas Discharge Lamps			
Plastics containing Brominated Flame Retardants			
Components and parts containing toner and ink, including liquids, semi-liquids (gel/paste), and toner	Include the cartridges, print heads, tubes, vent chambers, and service stations.		
Components and waste containing asbestos			
Components, parts, and materials containing refractory ceramic fibers			
Components, parts, and materials containing radioactive substances			



3. Disassemble Instructions

The intent of this document is to provide guidance to recyclers on the presence of materials and components at the product / family level, as required by the EU WEEE Directive 2012/10/EU. This document should also help direct recyclers to proper methods for removing parts and general product disassembly instructions.

This chapter consists of three subsections:

Recommended disassembly tools, disassembled flowchart, and step-by-step disassembly instructions to direct recycler proper methods to treat.





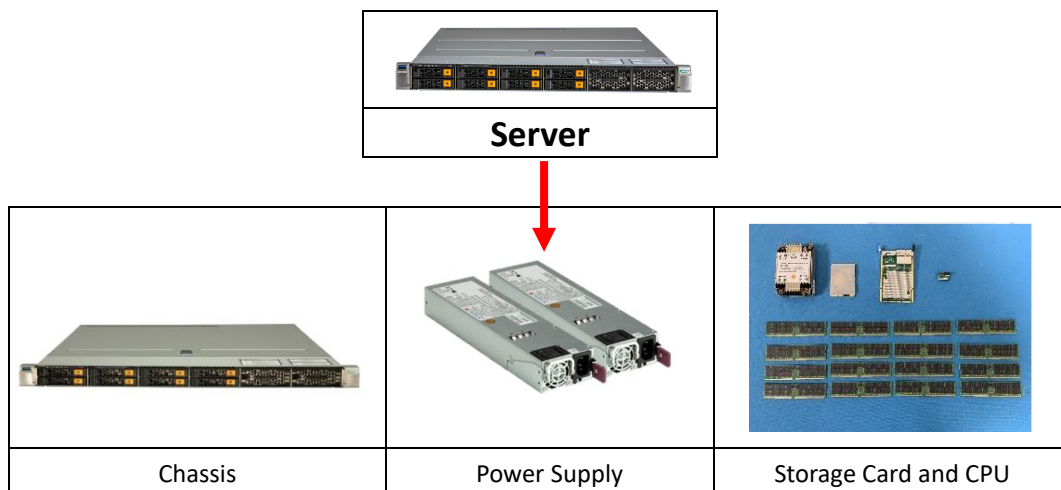

3.1 Recommended Disassembly Tools

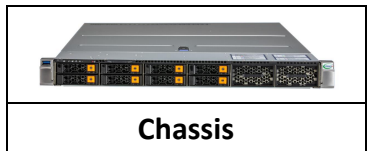
Disassembly tool	T30-bit screwdriver	
	Cross screwdriver	
	Flathead screwdriver	





3.2 Disassembled flowchart











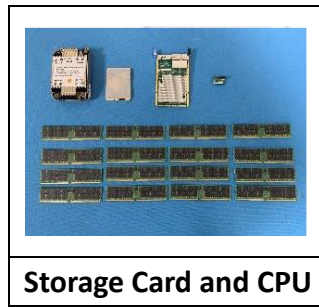

			
Backplane	Air Shroud	Screw	Fan
			
Motherboard and Other Curit Board	Motherboard and Other Circuit Board	Battery	



			
Power Enclosure*2	Screw and Standoff*2 Set	Power Supply Module*2	Power Cable

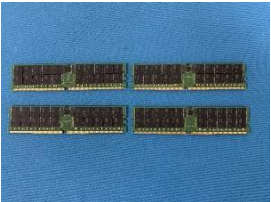

			
Heat Sink	Processor	SSD * 2set	AIOM
			
Add-on Card	DIMM	M.2 *8	TPM

3.3 Step-by-Step Disassembly Instructions

1. Removing Power Cable and Chassis Top Cover

1. Use the operating system to power down the system
2. After the system has completely shut-down, disconnect the power cords from the power supply modules
3. Remove all cables/ unit from the server IO port



1.1 Power Supplies

USB Ports
VGA Port
BMC LAN

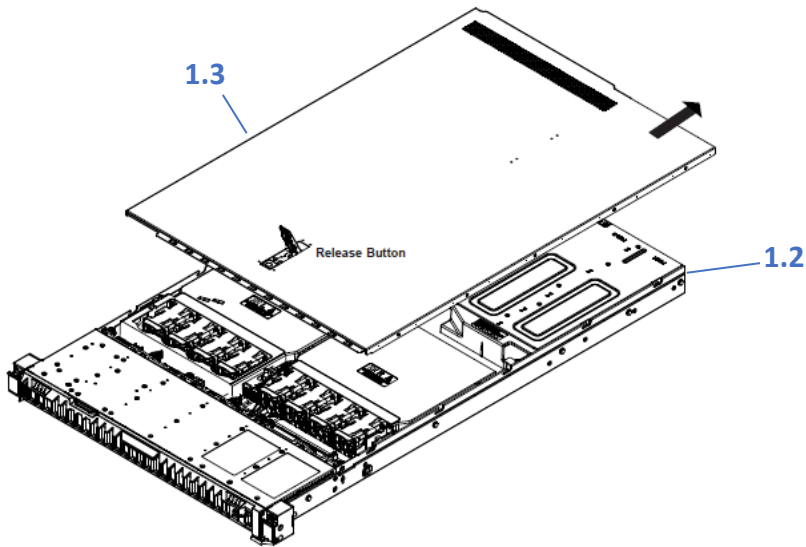

No.	Description
1.1	Power Cable
1.2	Chassis
1.3	Top Cover

2. Removing Hard Disk Drive (HDD)/ Solid State Drive (SSD)

1. Press the release button on the drive carrier, which will extend the drive carrier handle.
2. Use the drive carrier handle to pull the drive out of the chassis.

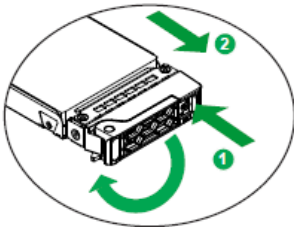

3. Remove the dummy tray insert by first removing two screws, then pull out the dummy tray

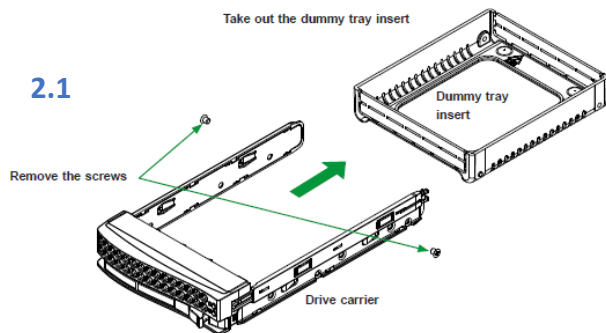

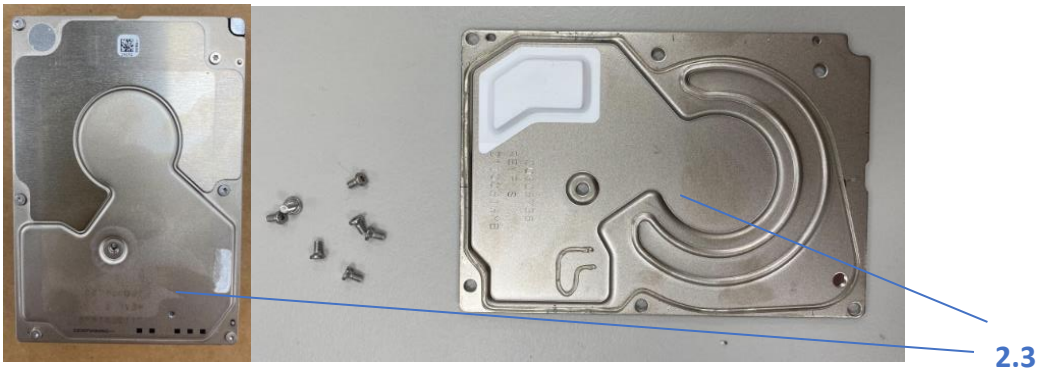

5. Use a cross screwdriver to remove drive enclosure

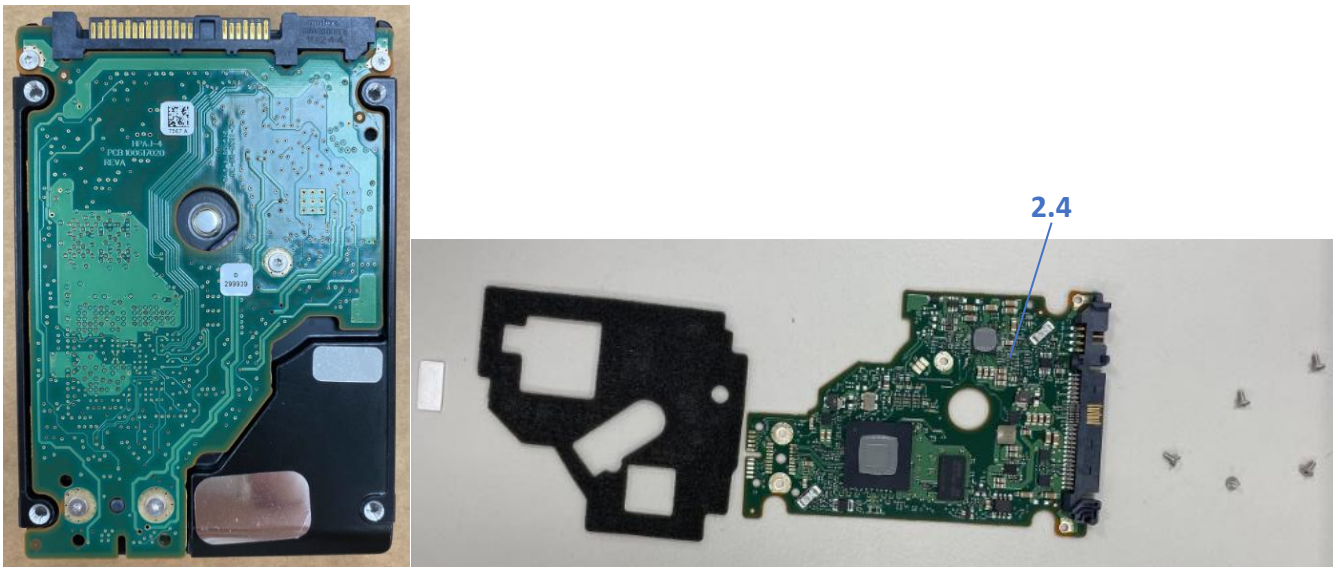

6. Use a cross screwdriver to remove screws and lift off the PCB

No.	Description
2.1	Dummy Tray
2.2	HDD/ SSD
2.3	Hard Drive Enclosure
2.4	HDD/ SSD PCB

3. Removing Power Supply

1. Press the release tab on the failed power supply
2. Use the handle to gently slide the power supply out the back of the chassis

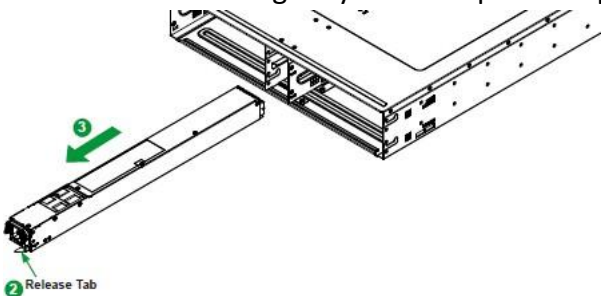

3. Remove the screw from the enclosure



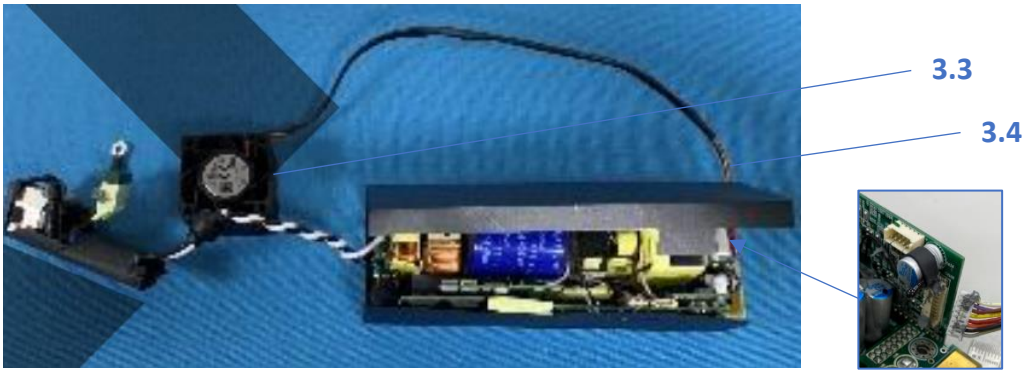

4. Disconnected to the fan and lift the main board from the chassis by hand



5. Use flathead screwdriver cutting capacitor adhesive and pin solder.



No.	Description
3.1	Power Supply
3.2	Power Enclosure
3.3	Fan
3.4	Fan Cable
3.5	Power Module PCB
3.6	Capacitor

4. Removing Backplane

1. Standoffs *3 (red) and secure with thumb screws *3 (yellow)



No.	Description
4.1	Backplane

5. Removing Fan

1. Squeeze the fan tabs and lift the fan housing up and out

6.1



No.	Description
5.1	Cooling Fan

6. Removing AIOM Card/ Add on Card/ TPM

1. Remove the blank cover plate(A1), unscrewing the thumbscrew.

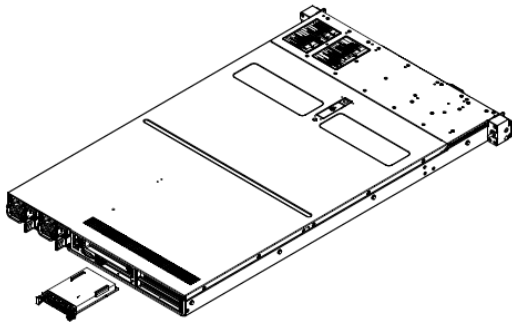

2. Press the pin and remove the pin and take off the PCB from AIOM



←

← 7.3 ←

3. Release add on card thumbscrew (yellow) and lift from chassis



6.2

4. Lift the add on card latch from chassis

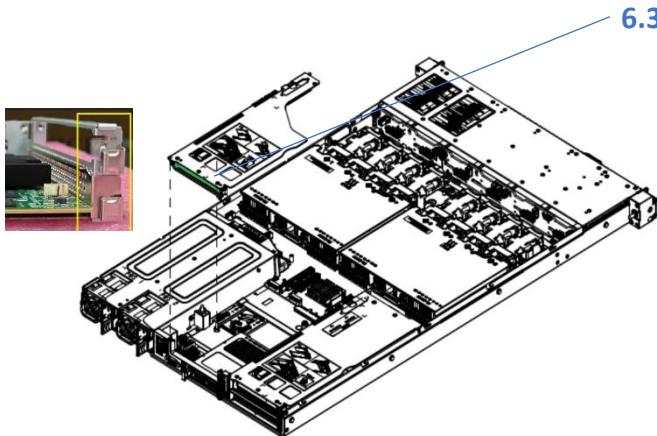

6.3

5. Pull up the TPM from motherboard key pin

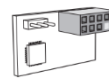
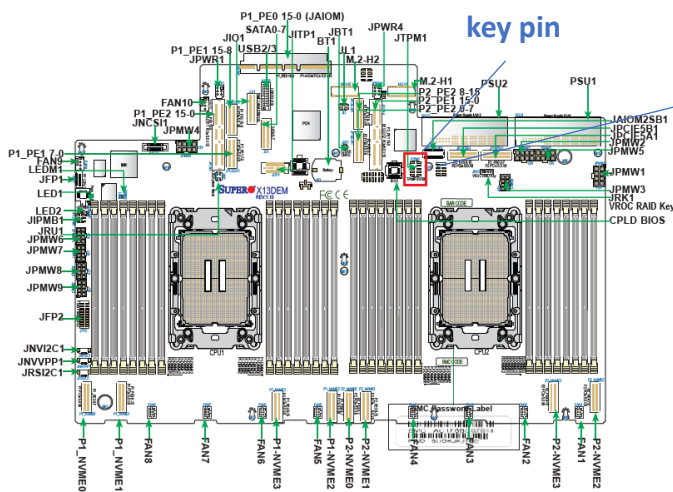

6.4

Horizontal TPM

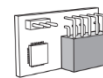

Vertical TPM

No.	Description
6.1	AIOM PCB
6.2	Add on Card
6.3	Add on Card
6.4	TPM

7. Removing Riser Card and Riser Bracket

1. Remove left riser bracket.
2. Secure with thumbscrew (yellow).

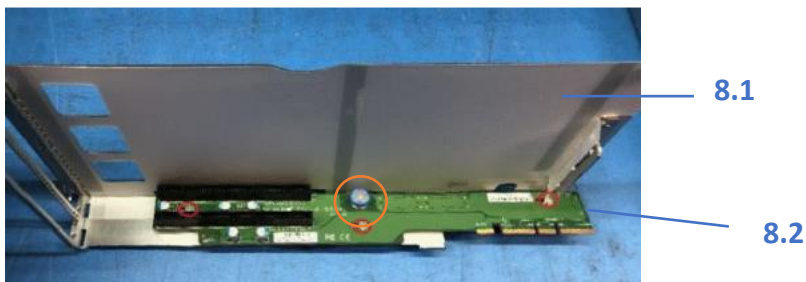

No.	Description
7.1	Riser Bracket
7.2	Riser Card

8. Removing Processor

1. Use a T30 screwdriver to loosen the four PEEK nuts on the heatsink in the sequence of A, B, C, and D

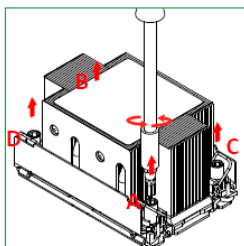

2. Once the PEEK nuts are loosened from the CPU socket, press the rotating wires inwards to unlatch the PHM from the socket as shown in the drawings below

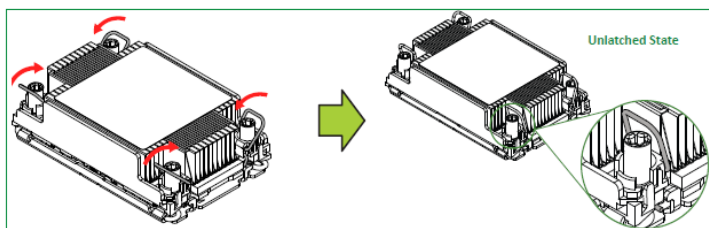

3. Gently pull the PHM upwards to remove it from the CPU socket

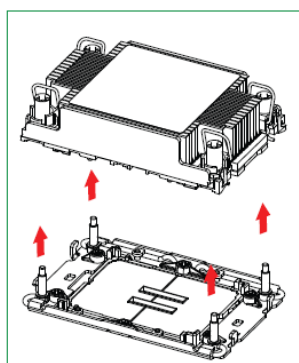

4. Detach the four plastic clips (marked a, b, c, d) on the processor carrier assembly from the four corners of the heatsink (marked A, B, C, D) as shown in the drawings below
 1U Heatsink (View of Component Side and Heatsink Bottom Side)

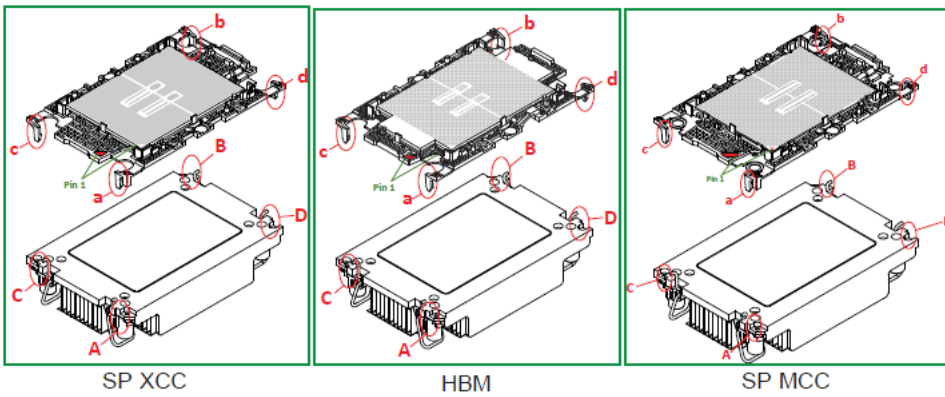

5. When all plastic clips are detached from the heatsink, remove the processor carrier assembly from the heatsink

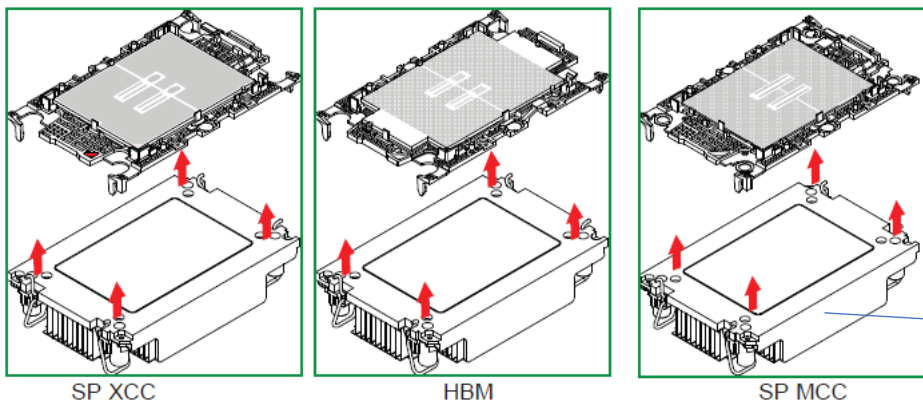

8.1

6. Unlock the lever from its locked position and push the lever upwards to disengage the processor from the processor carrier as shown in the drawing on the right below

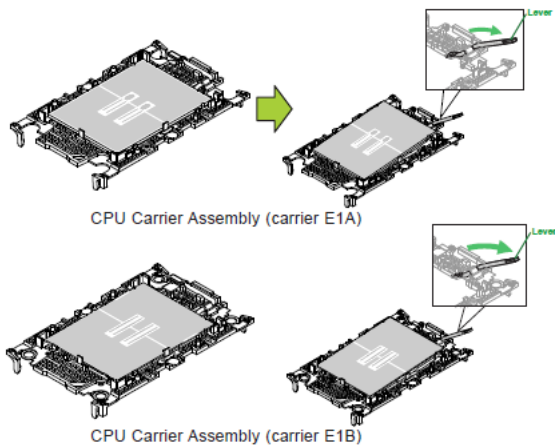

7. Once the processor has been loosened from the carrier, carefully remove the processor from the carrier

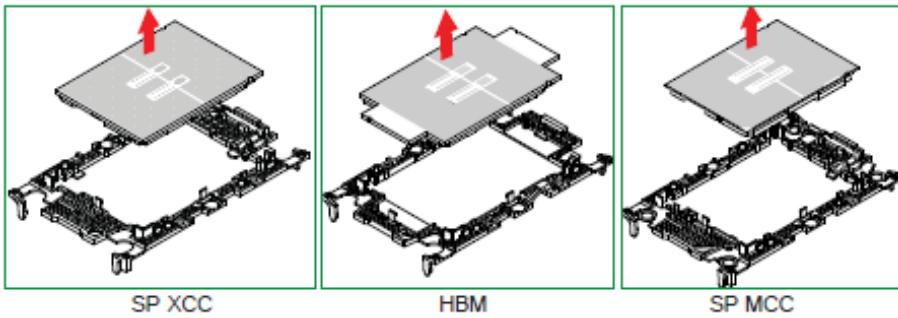

Note: Please handle the processor with care to avoid damaging it or its pins

No.	Description
8.1	Heat Sink
8.2	Processor

9. Removing DIMM

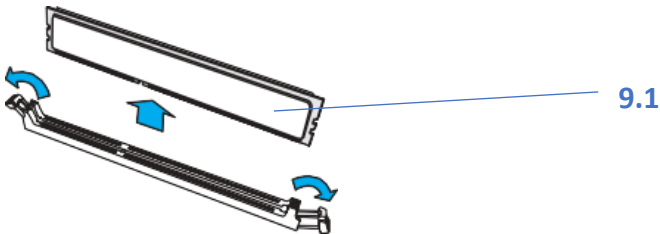

1. Hand press both release tabs on the ends of the DIMM module to unlock it
2. Once the DIMM module is loose, remove it from the memory slot

No.	Description
9.1	DIMM

10. Removing M.2

1. Refer to its layout image and locate the M.2 slot, remove the plastic clip from the hole the M.2 slot form the motherboard

2. Turn the plastic clip by 90° degrees, pick the M.2 up from the connector

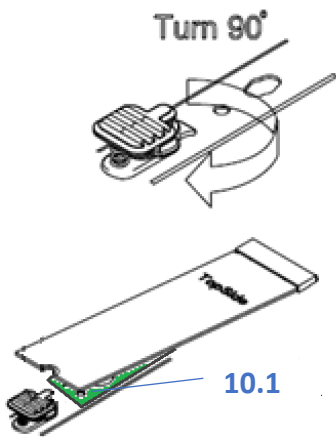

No.	Description
10.1	M.2

11. Removing Motherboard

1. Remove screws *6 (red) and thumb screws *2 (yellow), lift out motherboard
2. Push clamp that covers the edge of the battery. When the battery is released, lift it out

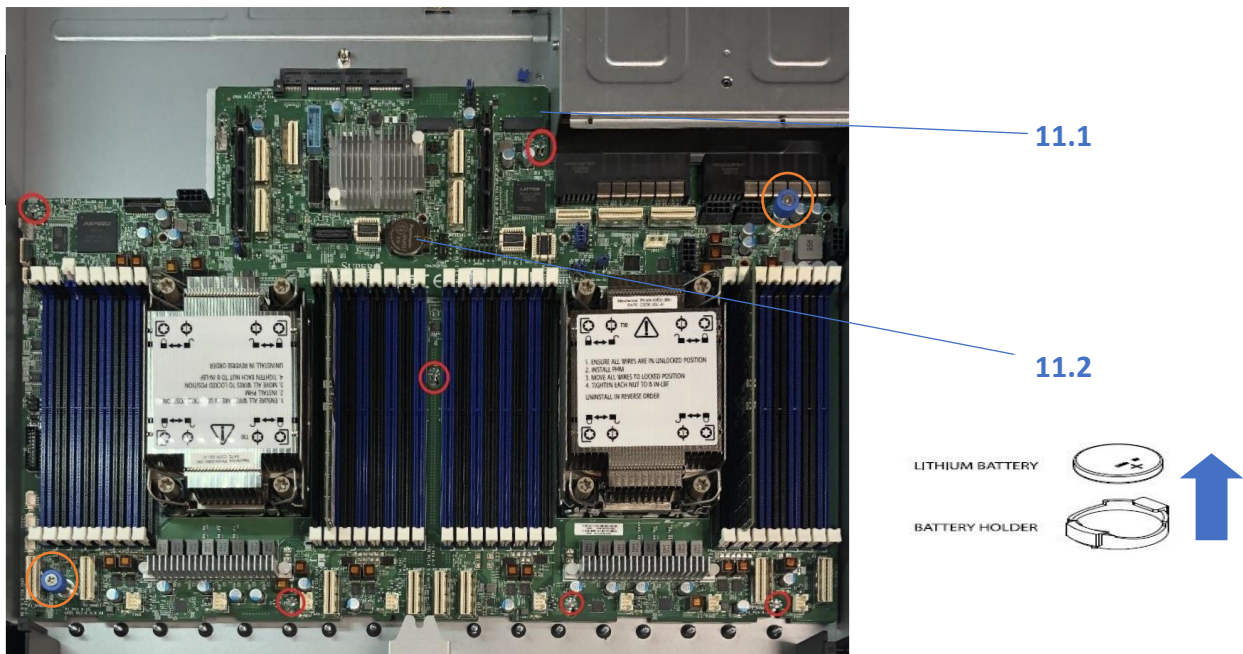

No.	Description
11.1	Motherboard
11.2	Battery